



# PERIOD WINDOWS



# The Tradition of Quality

In 1920 James Scott started a company producing specialist timber products. Founded on the principle of always putting quality first, the company has gone from strength to strength to become a leader in their field. Today, more than 85 years later, the family owned company is widely recognised as one of the country's foremost suppliers of period windows and bespoke doors.

Scotts produces a range of period timber windows which are, quite simply, second to none in terms of quality and performance. Years of careful product development, coupled with the skills of master craftsmen, has enabled the company to combine the charm and character of traditional windows with modern, Part L compliant, high-performance levels of insulation and security.

When quality matters, there's only one choice.



## BESPOKE

All of Scotts' windows are produced on a bespoke basis making selection of details an easy task – exact fenestration patterns, glazing selection and ironmongery are all individually chosen for each window.



## TIMBER

Durable, versatile and with a timeless elegance – timber is still the professionals' first choice for authentic, period windows and doors. A range of hardwoods and softwoods, all taken from managed resources, where possible, are available to suit individual requirements.

## SLENDER GLAZING BARS

Using the Scotts' "Slender Glazing Bar" system, all the windows have a traditional and elegant appearance, yet feature the benefits of double glazing to provide optimum thermal and acoustic insulation properties. In addition, Scotts offers sashes with individual double glazed units for both casement and sliding sash windows, French doors and external doors. These individual units maintain the narrow sight line for the glazing bars similar to the "stick-on" glazing bars which have been very popular in both conservation and other areas of the UK for differing styles of property.

# Sliding Sash Windows

Ingenious and practical, the sliding sash window system is a much-loved and prominent feature of period buildings across the country. Using traditional skills and high performance materials, Scotts' sliding sash windows are made in several styles making them ideal for use in new-build projects or as replacements for existing, dilapidated windows. Double weather stripping, brush seals and close tolerance manufacturing all combine to give the window excellent weather proofing capabilities.

## CONTENTS

### SLIDING SASH WINDOWS 3-5

Classic Georgian  
Slim Box Georgian  
Slide and Tilt Georgian  
Yorkshire Slider

### CASEMENT WINDOWS 6-7

Traditional Casement  
Easy-Clean Casement  
Landscape Casement  
Top Hung and Hopper Hung

### FRENCH DOORS 8-9

Materials  
Glazing  
Ironmongery

### SPECIAL PROJECTS 10

Curved Headed Windows  
Glazed Screens  
Oversize and Bespoke Projects

### SPECIFICATIONS 11

Part L Compliance  
Timber  
Ironmongery  
Glazing  
Finishing  
Supply  
Delivery and Protection  
General



1



2

Tested to 2000 Pascals of wind resistance – the equivalent of a 125mph gale – Scotts windows offer unrivalled levels of protection and are highly effective in exposed locations.



1 *Luxury private residence featuring a range of "Slim-Box Georgian" sliding sashes.*

2 *London city centre refurbishment, with a variety of "Classic Georgian" sliding sashes, casement windows and curved-headed sliding sash windows.*

# Sliding Sash Windows

## CLASSIC GEORGIAN

The ideal solution for listed buildings. Scotts' "Classic Georgian" window incorporates all the design features of the original – the slender glazing bars, narrow meeting stiles, simple ironmongery and clean lines – to create a faithful replica for today's building environment. Traditional weights and pulleys give an outstandingly smooth operation on even the largest installations. Meticulous attention to period detailing is carried through to the section profiles and ironmongery to produce an exceptional window.



## SLIDE AND TILT GEORGIAN

Designed to facilitate easy cleaning, the slide and tilt mechanism provides all the benefits of spiral balances with the added advantage of two tilting sashes. Discreet locking systems preserve the overall elegance of the window and maintain the period feel. Ideal for elevated locations where easy cleaning or emergency access is an important issue.



3



4

## SLIM-BOX GEORGIAN

For locations without a window reveal Scotts has designed the "Slim Box Georgian". Incorporating all the same design features of the Classic Georgian, but using spiral balances rather than weights and pulleys, the overall box depth is reduced by 50mm. Spiral balances offer a maintenance-free, smooth and effective running action and once fitted into standard openings, the exterior appearance is identical to the traditional, deep box sliding sash.

## YORKSHIRE SLIDER

A feature of some country properties, the "Yorkshire Slider" opens horizontally rather than vertically. Featuring all the advantages of the slender glazing bar system and with many other period details, the running gear provides a clean and positive action. Locking systems and fenestration details are designed to suit individual taste.

3 A renovated listed building using "Classic Georgian" sliding sash windows and matching French doors.

4 A "Yorkshire" and a "Classic Georgian" window sit side by side in this cottage.

5 "Classic Georgian" sliding sashes lend a timeless elegance to this luxury development.

6 The slender glazing system is used to good effect in this central London "Classic Georgian" sash window.

7 A range of "Slim-Box Georgian" sliding sashes.



5



6

**SCOTT'S' SLIDING SASH WINDOWS  
DETAILED SECTIONAL DRAWINGS**

All dimensions given in millimetres

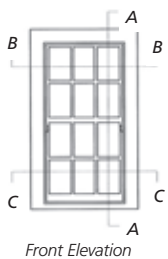

**CLASSIC GEORGIAN**

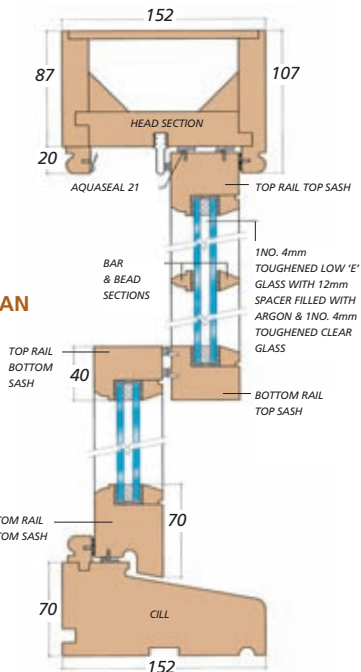

Section A - A

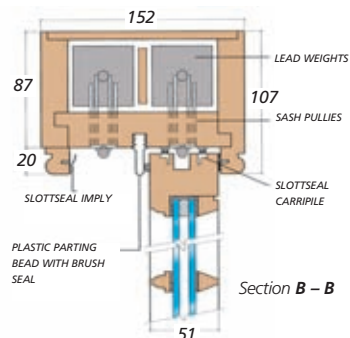

Section B - B

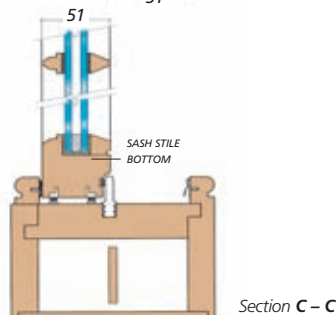

Section C - C

**SLIM BOX GEORGIAN**

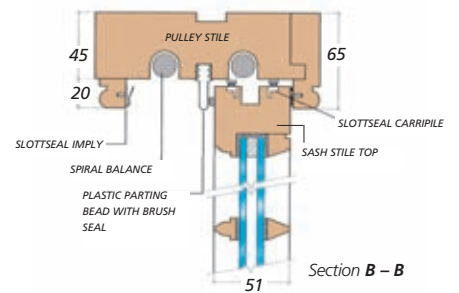

Section B - B

**SLIDE & TILT GEORGIAN**

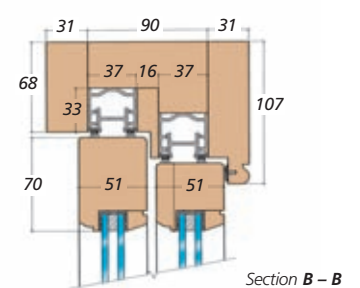

Section B - B

# Casement Windows

Scotts' traditionally styled casement windows offer excellent standards of security and insulation combined with an array of authentic period features. Perfectly suited to renovation or new-build projects, these windows feature the Scotts slender glazing bar system and are individually manufactured to meet your exact requirements.



## SCOTTS' EASY-CLEAN CASEMENT WINDOW

Stainless steel friction hinges and concealed espagnolette bolts give this window a smooth and simple operating action with the added comfort of high security, key operated locking systems. The hinges open to a full 90° on an offset pivot for easy cleaning of both sides of the glass.



## TRADITIONAL CASEMENT

A true stalwart of the range; this robust, flush fitting casement window, of mainly hardwood construction, is fitted with solid brass butt hinges, a traditional cockspur latch and a casement stay to produce a classic window. All manner of different fenestration patterns can be accommodated, including Gothic, Georgian and margin light detail. With a choice of period ironmongery and easy selection of other bespoke options, this window can be styled to blend in with surrounding architecture or to match existing windows.



1



2

## LANDSCAPE CASEMENT

A clear and uninterrupted view is exactly what this window provides with its specially designed arrangement of a pair of side-opening sashes without a central mullion. Modern espagnolette bolts offer high security and either stainless steel friction hinges or classic brass butt hinges afford a simple operating action. Easy selection of other bespoke options makes this a versatile window.

## TOP HUNG AND HOPPER HUNG

Using purpose designed ironmongery, most casement sashes can be hinged from the top or bottom where necessary. Elevated windows are supplied with extended poles and hooks for easy opening and closing.





5



3



4

**SCOTT'S' CASEMENT WINDOWS  
DETAILED SECTIONAL DRAWINGS**

All dimensions given in millimetres

**TRADITIONAL CASEMENT**

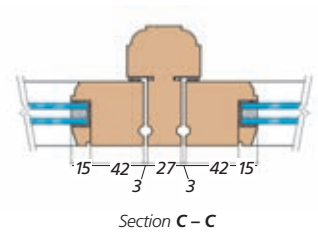

**MULLIONLESS CASEMENT**

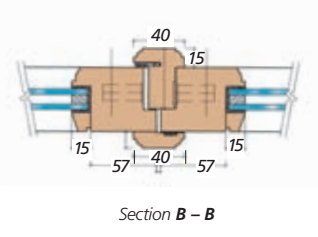

- 1 Traditional casements, with special ironmongery, are fitted into the stone mullions of this listed building.
- 2 A private residence in Hampstead featuring a range of traditional casement windows.
- 3 A curved window featuring a hopper-hung central casement panel.
- 4 Side opening and top-hung sashes feature Georgian style glazing bars in this listed building.
- 5 Traditional side-hung casement windows match adjacent architecture in this specialised new-build project; including bespoke colour paint finish and lead covered cills.

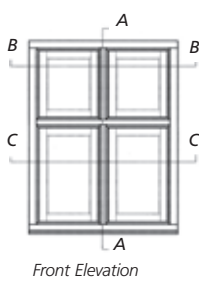

**TRADITIONAL CASEMENT**

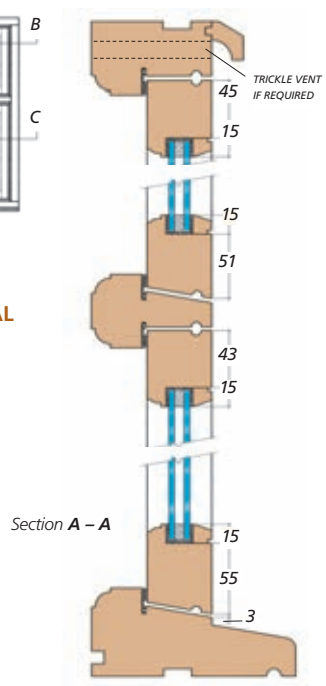

# French Doors

The best of both worlds - light floods in through the full height glazing yet you can have instant access to the pool, garden or terrace. The simple, high security locking systems mean that either one or both leaves can be opened and held in position by the integral friction stay.

Featuring the same standards of technical excellence and skilled craftsmanship as Scotts other products, and using the slender glazing bar system, the French Doors are a bespoke item, created to match your exact needs. For particularly exposed locations, deeper cill rebates and additional weather stripping helps to safeguard against the weather.

Fenestration patterns can be matched to adjacent windows, or created to blend in with existing architectural detail. The popular Gothic or margin light patterns can be used to accompany matching windows and doors can even be part glazed - part panelled, as desired.

## MATERIALS

All of Scotts' French Doors are made from hardwood in order to maintain structural integrity and prevent any unwanted movement in the construction. Kiln dried hardwood or sturdy, pressure-treated, joinery-grade softwood frames (if requested) and hardwood cills provide the ultimate in durability and longevity.

## GLAZING

Glazing options include obscured, toughened, tinted and laminated double glazed units as well as "anti-bandit" glass where security is a high priority. Single glazing and the bespoke options of leaded, stained glass and patterned, etched glass are also available where required.



1

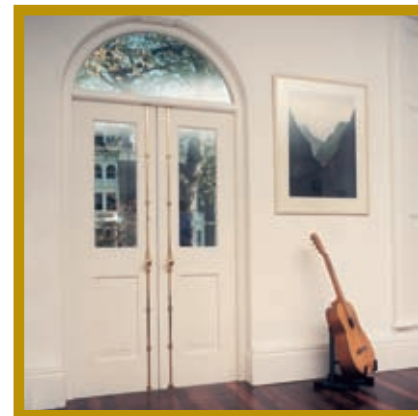

2

## IRONMONGERY

All doors are hung on traditional roller-bearing, solid brass butt hinges and fitted with concealed espagnolette bolts, giving the highest levels of security and ease of operation.

Rebated locks are available on request, along with a range of surface mounted espagnolette bolts or flush bolts. For additional security, locks can be for internal use only, with dummy escutcheons fitted to the exterior.





3



4

- 1 Three matching pairs of limed oak French doors open out onto the pool area in this private residence.
- 2 Pair of doors with surface mounted, brass espagnolette bolts and a curved-headed fanlight.
- 3 French doors and a sliding sash window, both created with margin-light detail to match existing architecture and to comply with planning regulations.
- 4 & 5 Two pairs of "Gothic" French Doors open this dining room out onto the terrace and create a versatile entertaining space.

**SCOTT'S' FRENCH DOORS  
DETAILED SECTIONAL DRAWINGS**

All dimensions given in millimetres

Meeting stiles – Opening Out

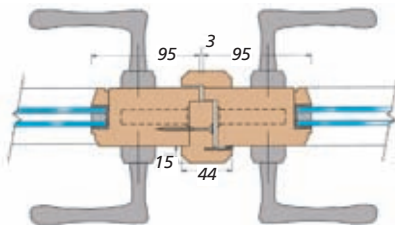

Meeting stiles – Opening In

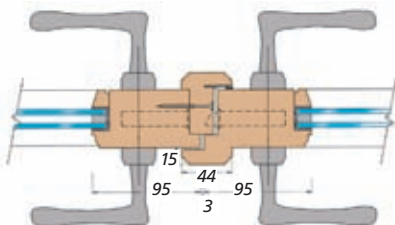

**GLAZED  
DOOR**

**RAISED &  
FIELDIED**

**BOARDED  
DOOR**

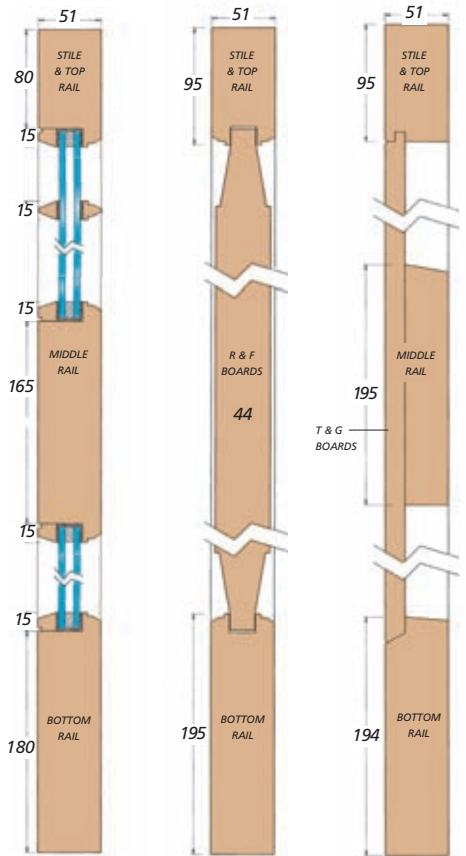

5

# Special Projects

Innovative design, creativity and imagination are essential elements in every memorable building. As specialist joiners, Scotts is able to create highly individual and stunning joinery schemes at its purpose built factory in Thrapston, Northamptonshire. Whether it is for a conceptual commercial development or a traditional period residence, the range of options and possibilities is almost endless.

## CURVED-HEADED WINDOWS

Many buildings owe their good looks to some distinctive curved-headed windows. Scotts is able to manufacture a range of double-glazed casement or sliding-sash windows to suit individual requirements and match existing radius specification. Traditional appearance is retained using the slender glazing bar system and, again, ironmongery and glazing options are flexible.



1



2

## GLAZED SCREENS

A feature of many luxury developments, the glazed screen can divide large living areas or create a division between a pool area and the rest of the house. In commercial developments, the screen is often used to separate spaces whilst allowing light to move freely. All items are bespoke features and built in close co-operation with architect and contractor.

## OVERSIZE AND BESPOKE PROJECTS

Public buildings, churches, grand houses or municipal spaces will often have extravagant windows that match the scale of the building. The specialist skills and experience that Scotts has accumulated, over 85 years, allows it to handle such projects with confidence.

- 1 *Limed oak, double glazed screens in a private pool complex.*
- 2 *A centrally pivoting, oval window with margin-light detail to match existing.*
- 3 *The curved-headed, 5m tall, windows in this school library feature the original 1920's stained glass panels.*
- 4 *Viewed from inside, this curved-headed "Classic Georgian" window with "Gothic" glazing bar detail affords a grand view.*
- 5 *Curved-headed, "Classic Georgian" sliding sash window - over 4m in height and set into stone reveals.*

# Specifications

## PART L COMPLIANCE

Every Scotts window type has been assessed by TRADA (Timber Research and Development Association) and passed as being fully compliant with the new, tougher building regulations. Great care has been taken to meet the required Part L standard whilst using timber construction and retaining the traditional period details.

## TIMBER

All timber, hardwood or softwood, is taken from managed resources, where possible, compliant with BS 1186 Part 1. Softwood is pressure treated to BS 5707 Part 1 against fungal or insect attack. Minor irregularities in the nature of this material are to be expected and may possibly affect the performance characteristics of certain elements. Regular maintenance, in accordance with the company's directions, is required in order for company guarantees to be effective.

## IRONMONGERY

High quality ironmongery is used throughout and options include brass, polished nickel and chrome. Laquered components should not be cleaned with abrasive substances, but with a soft damp cloth.

## GLAZING

All glazing options comply with BS 5713. Double glazed units are manufactured from Low 'E' glass with a 90% Argon filled void as standard. Single glazing is available.

## FINISHING

Standard factory finishing of all units consists of a microporous, sprayed paint application. The paint finish has a 3 – 10 year guarantee, depending on whether an opaque or translucent finish is applied. This guarantee is, however, dependent on the prevailing atmospheric location and weather / climatic conditions. Weather-stripping and brush seals are fitted in accordance with BS 6375 Part 1 & 2.

## SUPPLY

Scotts of Thrapston offers a supply only service for period windows. It is the customer's responsibility to arrange installation of the windows.

## DELIVERY & PROTECTION

All units come wrapped in bubble-wrap as standard. It is strongly advised that windows stored on site should be protected from the elements and stood upright in a dry, ventilated area. Do not stack windows. Once windows are installed, heating systems should be introduced gradually to prevent rapid climate change. Site conditions should be maintained between 13°C and 21°C, at 40-60% RH.

## GENERAL

If any further advice or information is required, please contact Scotts technical advice team, or alternatively reference can be made to BS 8214:1990 code of practice.

Whilst every effort has been made to ensure that the details displayed in this brochure are correct, Scotts reserves the right to amend specifications without notice. All diagrams included in this brochure are for illustration only and are not to scale.

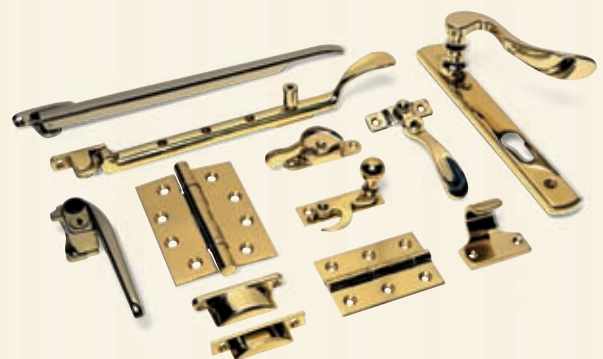



## Performance Doors

From basic primed flush doors through to the highest quality inlaid veneer or panelled doors, Scotts has the solution to meet most commercial or residential applications. The Scotts range of fire, acoustic, security and other performance doors are also tailored to suit individual customer requirements, whether for refurbishment or new build projects.

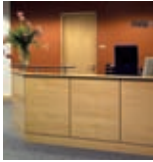

## Joinery

For many years, Scotts has had an enviable reputation for producing bespoke joinery, of the highest quality, for both commercial and domestic projects. Scotts also provides a dedicated CNC routing service, for a wide variety of applications, whether for short or long runs or even one-off specials.



## Roof Structures

As a leading member of the Trussed Rafter Association, Scotts can design and supply all structural roof components from trussed rafters and room-in-the-roof trusses to roof structures for special applications. Scotts is the preferred supplier to many leading UK housebuilders and construction companies, handling a diverse range of projects.



## Engineered Floors

The easi-joist engineered floor system from Scotts provides a practical, cost effective alternative to traditional timber joists, whether for domestic or commercial applications. A precision designed and manufactured floor system, easi-joist combines stress graded timber with engineered metal webs to create a flooring solution to suit your specification.



## Summerhouses and Pavilions

Scotts manufactures and supplies distinguished summerhouses and pavilions as well as a wide range of leisure buildings, for a variety of purposes. The range of sumptuous summerhouses will enhance any garden setting and provide the perfect hideaway whilst every pavilion is purpose designed and manufactured to suit your exact needs.



## Equestrian Buildings

Scotts is the country's leading supplier of bespoke timber equestrian buildings with an unrivalled reputation for design, quality and customer service. The Scotts service includes initial design through to on-site construction. Whether a complete yard complex or a simple field shelter is required, Scotts provides the perfect solution for you and your horses.



## Garages and Outbuildings

Scotts garages and workshops can be created to accommodate your treasured motor vehicle, whether a cherished classic car or motorbike or a family runabout. Scotts offers two main garage building styles including the cost-effective, interlocking Standard Range and the Bespoke Range for more specific and unique applications.



### Scotts of Thrapston Ltd.

Bridge Street, Thrapston, Northamptonshire. NN14 4LR. Tel: 01832 732366 Fax: 01832 733703  
Email: [joinery@scottsofthrapston.co.uk](mailto:joinery@scottsofthrapston.co.uk)

[www.scottsofthrapston.co.uk](http://www.scottsofthrapston.co.uk)

